

C42 Audio Control Center

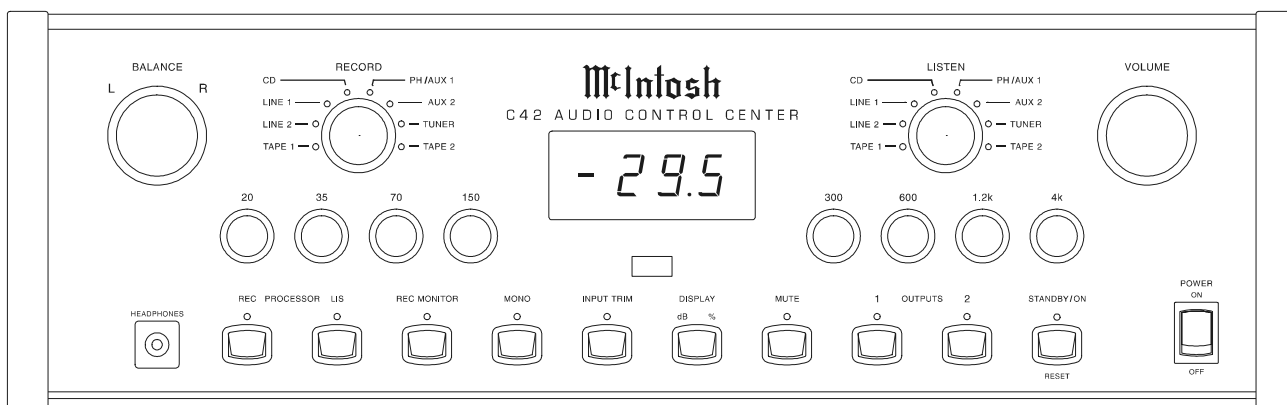

C42

Thank You

Your decision to own this McIntosh C42 Audio Control Center ranks you at the very top among discriminating music listeners. You now have “The Best.” The McIntosh dedication to “Quality,” is assurance that you will receive many years of musical enjoyment from this unit.

Please take a short time to read the information in this manual. We want you to be as familiar as possible with all the features and functions of your new McIntosh.

Please Take A Moment

The serial number, purchase date and McIntosh dealer name are important to you for possible insurance claim or future service. The spaces below have been provided for you to record that information:

Serial Number: _____

Purchase Date: _____

Dealer Name: _____

Technical Assistance

If at any time you have questions about your McIntosh product, contact your McIntosh dealer who is familiar with your McIntosh equipment and any other brands that may be part of your system. If you or your dealer wish additional help concerning a suspected problem, you can receive technical assistance for all McIntosh products at:

McIntosh Sales Corporation
661 W. Redondo Beach Blvd.
Gardena, CA 90247
Phone: 888-979-3737
Fax: 310-217-9288

Customer Service

If it is determined that your McIntosh product is in need of repair, you can return it to your dealer. You can also return it to the McIntosh Laboratory Service Repair department. For assistance on factory repair return procedure, contact the McIntosh Repair Department at:

McIntosh Laboratory, Inc.
2 Chambers Street
Binghamton, New York 13903
Phone: 607-723-3515
Fax: 607-723-1917

Copyright 1998 © by McIntosh Laboratory, Inc.

Table of Contents

Thank You	2
Please Take a Moment	2
Technical Support	2
Customer Service	2
Table of Contents	2
Safety Instructions	3
Introduction	4
Performance Features	4
Installation	5
Rear Panel Connections and Switch	6
How to Connect the C42	7
Front Panel Controls, Displays, Push-Buttons, and Switch	8
How to Trim Input Volume Levels	9
How to Operate the C42	10
Remote Control Push-Buttons	11
How to Operate by Remote Control	12
Specifications and Performance Chart	14
Packing Instruction	15

NOTES:

- The following Connecting Cable is available from the McIntosh Parts Department:
Data and Power Control Cable Part No. 170-202
Six foot, shielded 2 conductor, with 1/8 inch stereo mini phone plugs on each end.*
- For additional connection information, refer to the owner's manual(s) for any component(s) connected to the C42 Audio Control Center.*
- There is a built-in turn on delay which will mute the outputs for approximately two seconds when turned on.*
- “dB” is an abbreviation of the word decibel, which is a unit measure of sound intensity.*
- Balanced and Unbalanced Inputs and Outputs can be mixed. For example, you may connect signal sources to Unbalanced Inputs and feed signals out from the Balanced Outputs. You can also use Balanced and Unbalanced outputs simultaneously, connected to different power amplifiers.*
- Pin configuration for the XLR Balanced Input/Output connectors on the C42: PIN 1: Shield or ground.
PIN 2: + input.
PIN 3: - input.*

IMPORTANT SAFETY INSTRUCTIONS!

PLEASE READ THEM BEFORE OPERATING THIS EQUIPMENT.



WARNING SHOCK HAZARD - DO NOT OPEN.

The lightning flash with arrowhead, within an equilateral triangle, is intended to alert the user to the presence of uninsulated "dangerous voltage" within the product's enclosure that may be of sufficient magnitude to constitute a risk of electric shock to persons.



AVIS RISQUE DE CHOC - NE PAS OUVRIR.

The exclamation point within an equilateral triangle is intended to alert the user to the presence of important operating and maintenance (servicing) instructions in the literature accompanying the appliance.

CAUTION
RISK OF ELECTRIC SHOCK
DO NOT OPEN

ATTENTION
DANGER D'ELECTROCUTION
NE PAS OUVRIR

NO USER-SERVICEABLE PARTS INSIDE. REFER SERVICING TO QUALIFIED PERSONNEL

To prevent the risk of electric shock, do not remove cover (or back). No user serviceable parts inside. Refer servicing to qualified personnel.

General:

1. Read all the safety and operating instructions, contained in this owner's manual, before operating this equipment.
2. Retain this owner's manual for future reference about safety and operating instructions.
3. Adhere to all warnings and operating instructions.
4. Follow all operating and use instructions.
5. **Warning: To reduce risk of fire or electrical shock, do not expose this equipment to rain or moisture. This unit is capable of producing high sound pressure levels. Continued exposure to high sound pressure levels can cause permanent hearing impairment or loss. User caution is advised and ear protection is recommended when playing at high volumes.**
6. **Caution: to prevent electrical shock do not use this (polarized) plug with an extension cord, receptacle or other outlet unless the blades can be fully inserted to prevent blade exposure.**

Attention: pour prevenir les chocs electriques pas utiliser cette fiche polarisee avec un prolongateur, une prise de courant ou un autre sortie de courant, sauf si les lames peuvent etre inserees afond ans en laisser aucune partie a decouvert.

7. For added protection for this product during a lightning storm, or when it is left unattended and unused for long periods of time, unplug it from the wall outlet. This will prevent damage to the product due to lightning or power line surges.
8. Do not use attachments not recommended in this owner's manual as they may cause hazards.

Installation:

9. Locate the equipment for proper ventilation. For example, the equipment should not be placed on a bed, sofa, rug, or similar surface that may block ventilation openings; or, placed in a built-in installation, such as a bookcase or cabinet, that may impede the flow of air through the ventilation openings.
10. Locate the equipment away from heat sources such as radiators, heat registers, stoves, or other appliance (including amplifiers) that produce heat.
11. Mount the equipment in a wall or cabinet only as described in this owner's manual.
12. Do not use this equipment near water; for example, near a bathtub, washbowl, kitchen sink, laundry tub, in a wet basement or near a swimming pool, etc.
13. Do not place this product on an unstable cart, stand, tripod, bracket, or table. The equipment may fall, causing serious injury to a person, and serious damage to the product.

Connection:

14. Connect this equipment only to the type of AC power source as marked on the unit.
15. Route AC power cords so that they are not likely to be walked on or pinched by items placed upon or against them, paying particular attention to cords at plugs, convenience receptacles, and the point where they exit from the instrument.
16. Do not defeat the inherent design features of the polarized plug. Non-polarized line cord adapters will defeat the safety provided by the polarized AC plug. If the plug should fail to fit, contact your electrician to replace your obsolete outlet. Do not defeat the safety purpose of the grounding-type plug.

17. Do not overload wall outlets, extension cords or integral convenience receptacles as this can result in a risk of fire or electric shock.

Care of Equipment:

18. Clean the instrument by dusting with a dry cloth. Unplug this equipment from the wall outlet and clean the panel with a cloth moistened with a window cleaner. Do not use liquid cleaners or aerosol cleaners.
19. Do not permit objects of any kind to be pushed and/or fall into the equipment through enclosure openings. Never spill liquids into the equipment through enclosure openings.
20. Unplug the power cord from the AC power outlet when left unused for a long period of time.

Repair of Equipment:

21. Unplug this equipment from the wall outlet and refer servicing to a qualified service personnel under the following conditions:
 - a. The AC power cord or the plug has been damaged.
 - b. Objects have fallen, or liquid has been spilled into the equipment.
 - c. The equipment has been exposed to rain or water.
 - d. The equipment does not operate normally by following the operating instructions contained within this owner's manual. Adjust only those controls that are covered by the operating instructions, as an improper adjustment of other controls may result in damage and will often require extensive work by a qualified technician to restore the product to its normal operation.
 - e. The equipment has been dropped or damaged in any way.
 - f. The equipment exhibits a distinct change in performance - this indicates a need for service.
22. Do not attempt to service beyond that described in the operating instructions. All other service should be referred to qualified service personnel.
23. When replacement parts are required, be sure the service technician has used replacement parts specified by McIntosh or have the same characteristics as the original part. Unauthorized substitutions may result in fire, electric shock, or other hazards.
24. Upon completion of any service or repairs to this product, ask the service technician to perform safety checks to determine that the product is in proper operating condition.

Introduction

The new McIntosh C42 Stereo Preamplifier offers a highly refined combination of useful operating features with totally transparent electronic performance. For example you can take advantage of the eight-band equalizer to achieve the finest possible reproduction of digital source music as well as valuable music from earlier recording technology. Combine a C42 with a McIntosh Power Amplifier and you will enjoy a stereo system of unparalleled performance.

Performance Features

● **Balanced and Unbalanced Inputs/Outputs**

Eight unbalanced inputs, and three unbalanced outputs are provided. One balanced input, and three balanced outputs are also included. The Aux input can be switched to accept a moving magnet phono cartridge.

● **Precision Tracking Volume Control and Display**

A microprocessor logarithmic attenuator controls volume levels with a tracking accuracy of 0.1dB. Levels change in 213 individual steps of 0.5dB. The front panel digital display indicates the preamplifier gain in dB or percentage of available volume.

● **Input Level Matching**

Adjust the input volume levels of source components so they match the tuner input level.

● **Ultra Low Distortion**

Distortion levels of all types are less than 0.002%. Music is amplified with total transparency and accuracy.

● **Full Featured Remote Control**

Full Featured Remote Control is included that will allow complete control of major front panel controls and switches.

● **Eight Band Program Equalizer**

The equalizer provides 10dB of boost or cut at center frequencies of 20, 35, 70, 150, 300, 600, 1200 and 4000Hz. When an equalizer control is in the center or flat position, all equalizer circuit components are removed from the signal path.

● **Two Signal Processor Loops**

Separate front panel switched signal processor loops are provided for the listen and record circuits.

Installation

The C42 can be placed upright on a table or shelf, standing on its four feet. It also can be custom installed in a piece of furniture or cabinet of your choice. The required panel cut-out, ventilation cutout and unit dimensions are shown.

Always provide adequate ventilation for your C42. Cool operation ensures the longest possible operating life for any electronic instrument. Do not install the C42 directly above a heat generating component such as a high powered amplifier. If all the components are installed in a single cabinet, a quiet running ventilation fan can be a definite asset in maintaining all the system components at the

coolest possible operating temperature.

A custom cabinet installation should provide the following minimum spacing dimensions for cool operation. Allow at least 2 inches (5.1cm) above the unit and 1 inch (2.54cm) on each side of the control center, so that airflow is not obstructed. Allow 21 inches (53.3cm) depth behind the mounting panel, which includes clearance for connectors. Allow 1-1/8 inches (2.9cm) in front of the mounting panel for knob clearance. Be sure to cut out a ventilation hole in the mounting shelf according to the dimensions in the drawing.

Front View of C42 custom installed

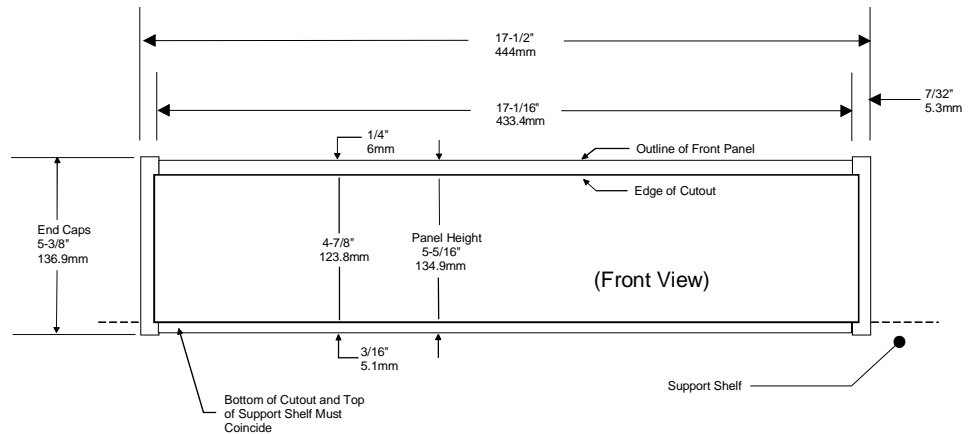

Side View of the C42 custom installed

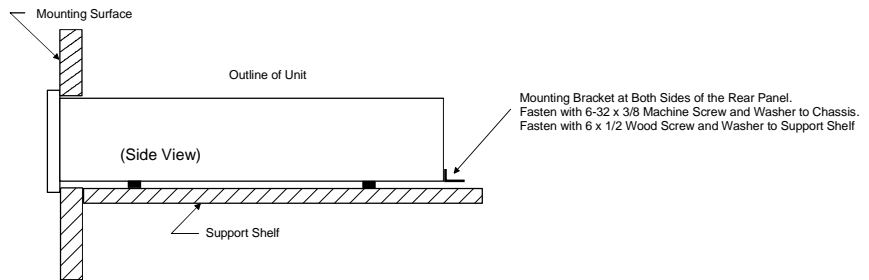

Bottom View of the C42 custom installed

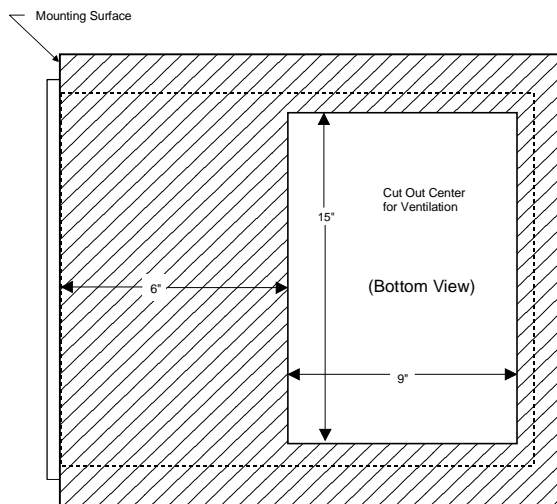

C42 Rear Panel Connections and Switch

Connect the C42 power cord to a live AC outlet. Refer to information on the back panel of your C42 to determine the correct voltage for your unit

POWER CONTROL MAIN Output sends a turn-on signal to a McIntosh Power Amplifier when the C42 is turned on

DATA PORTS send signals to compatible source components to allow you to control them with the remote control

1 and 2 Balanced OUTPUTS contain Listen signals and turn on/off with the front panel **OUTPUTS** push-buttons

POWER CONTROL ACC Output sends a turn-on signal to a McIntosh Power Control unit when the C42 is turned on

POWER CONTROL 1 and 2 Outputs send turn-on signal to a McIntosh Power Amplifier when the C42 Front Panel Output 1 and/or 2 is on

MAIN Balanced OUTPUTS contain Listen program signals at all times

LINE 1 balanced **INPUTS** accept high level program source signals

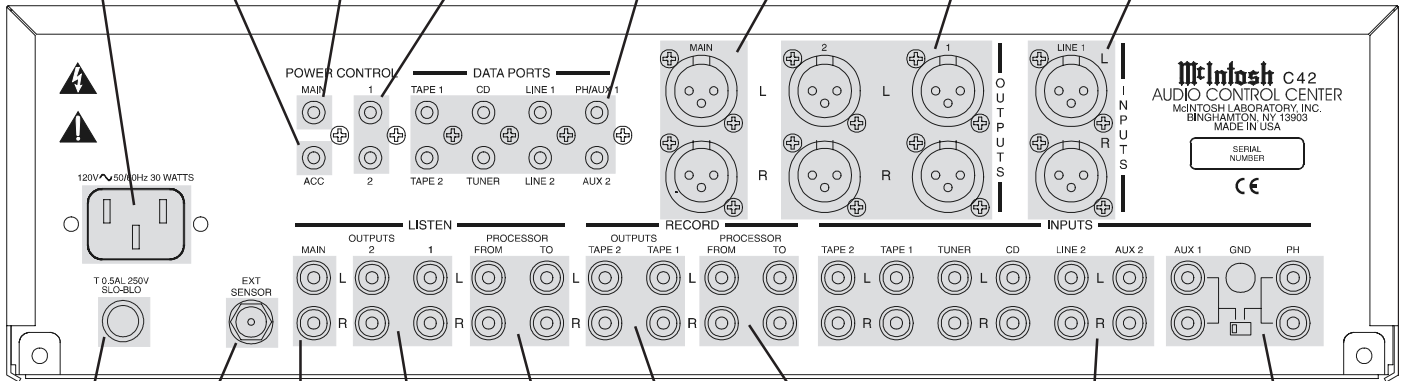

The **EXT** (external) Sensor jack allows you to connect a McIntosh IR sensor for remote operation

LISTEN OUTPUTS 1 and 2 contain Listen signals and turn on/off with the front panel **OUTPUTS** push-buttons

TAPE 1 and TAPE 2 OUTPUTS contain record out signals

RECORD PROCESSOR FROM and TO allows an external signal processor to be connected for use in the Record mode

AUX 1 accepts high level program source signals, **PH** accepts signals from a Moving Magnet phono cartridge, and the small slide switch selects which one of these two inputs is active when either front panel **LISTEN** or **RECORD** switch is set to **PH/AUX 1**

Main Fuse holder, refer to information on the back panel of your C42 to determine the correct fuse size and rating

LISTEN MAIN OUTPUTS contain Listen program signals at all times

LISTEN PROCESSOR FROM and TO allows an external signal processor to be connected for use in the Listen mode

TAPE 1, TAPE 2, TUNER, CD, LINE 2 and AUX2 INPUTS accept high level program source signals

How to Connect the C42

1. Plug the C42 AC power cord into a live AC outlet.
 2. Connect balanced cables from the balanced MAIN OUTPUTS to balanced power amplifier inputs.
 3. Connect cables from the C42 LISTEN PROCESSOR FROM jacks to the outputs of a signal processor. Connect cables from the C42 LISTEN PROCESSOR TO jacks to the signal processor inputs.
- Note: Connect a signal processor to the RECORD PROCESSOR jacks in a similar manner.*
4. Connect cables from RECORD TAPE 1 OUTPUTS to high level record inputs of a tape recorder. Connect cables from the C42 TAPE 1 INPUTS to the outputs of a tape recorder.
 5. Connect cables from the C42 CD INPUTS to the outputs of a CD Player.
 6. Connect cables from the C42 TUNER INPUTS to the outputs of a tuner.
 7. Connect a Power Control cable from the C42 MAIN

- POWER CONTROL jack to control the POWER CONTROL IN of a McIntosh power amplifier.
8. Connect a Power Control cable from the C42 POWER CONTROL ACC jack to the Power Control In of a McIntosh tuner.
9. Connect a Data cable from the C42 CD DATA PORT to the DATA IN of a McIntosh CD player.
10. Connect a Data cable from the C42 TUNER DATA PORT to the DATA IN of a McIntosh tuner.
11. Connect an RG6 or RG59U coaxial cable from the EXT (external) Sensor jack to an IR sensor.

NOTE: Balanced and Unbalanced Inputs and Outputs can be mixed. For example, you may connect signal sources to Unbalanced Inputs and feed signals out from the Balanced Outputs. You can also use Balanced and Unbalanced outputs simultaneously, connected to different power amplifiers.

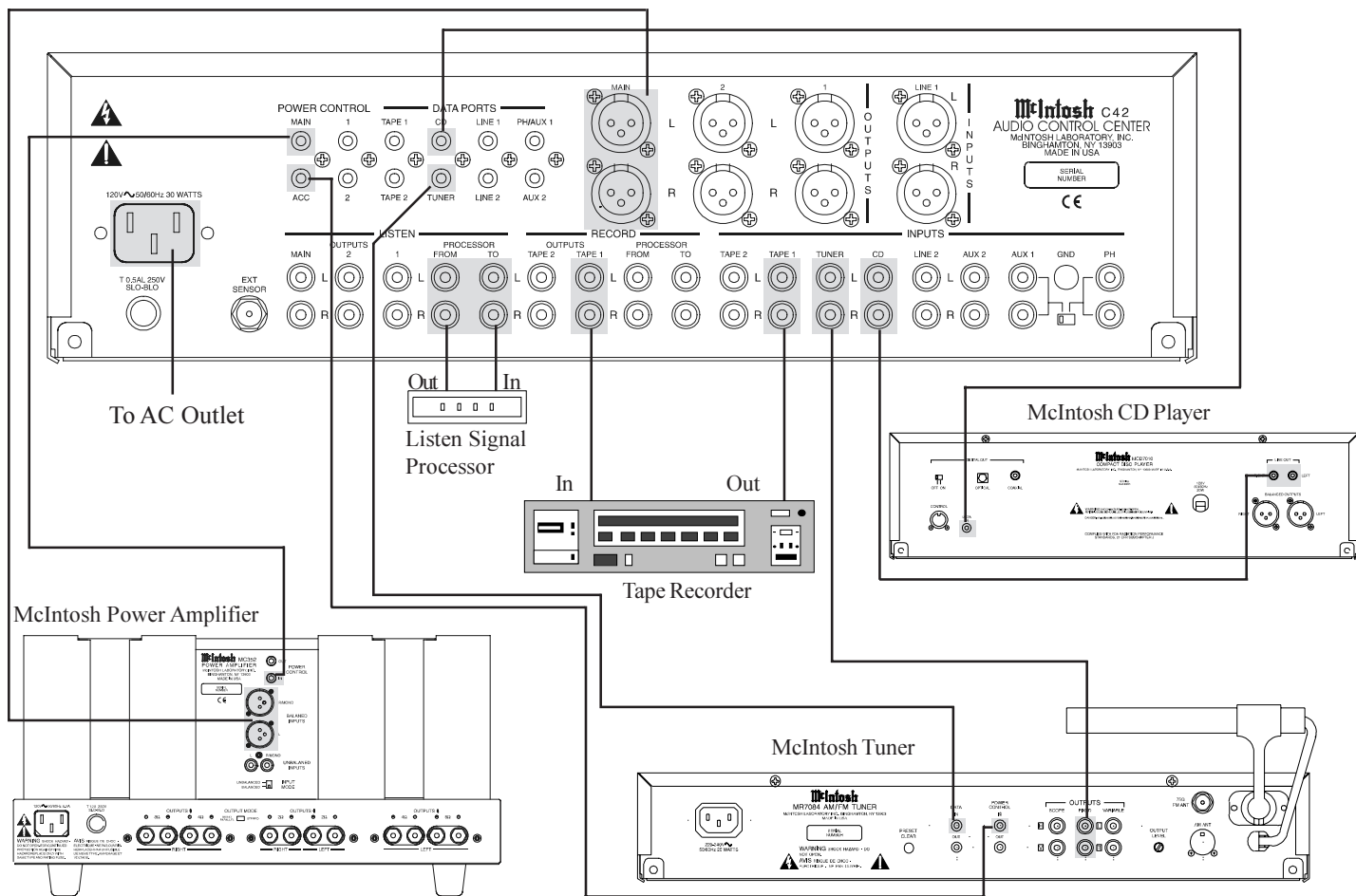

C42 Front Panel Controls, Displays, Push-Buttons, and Switch

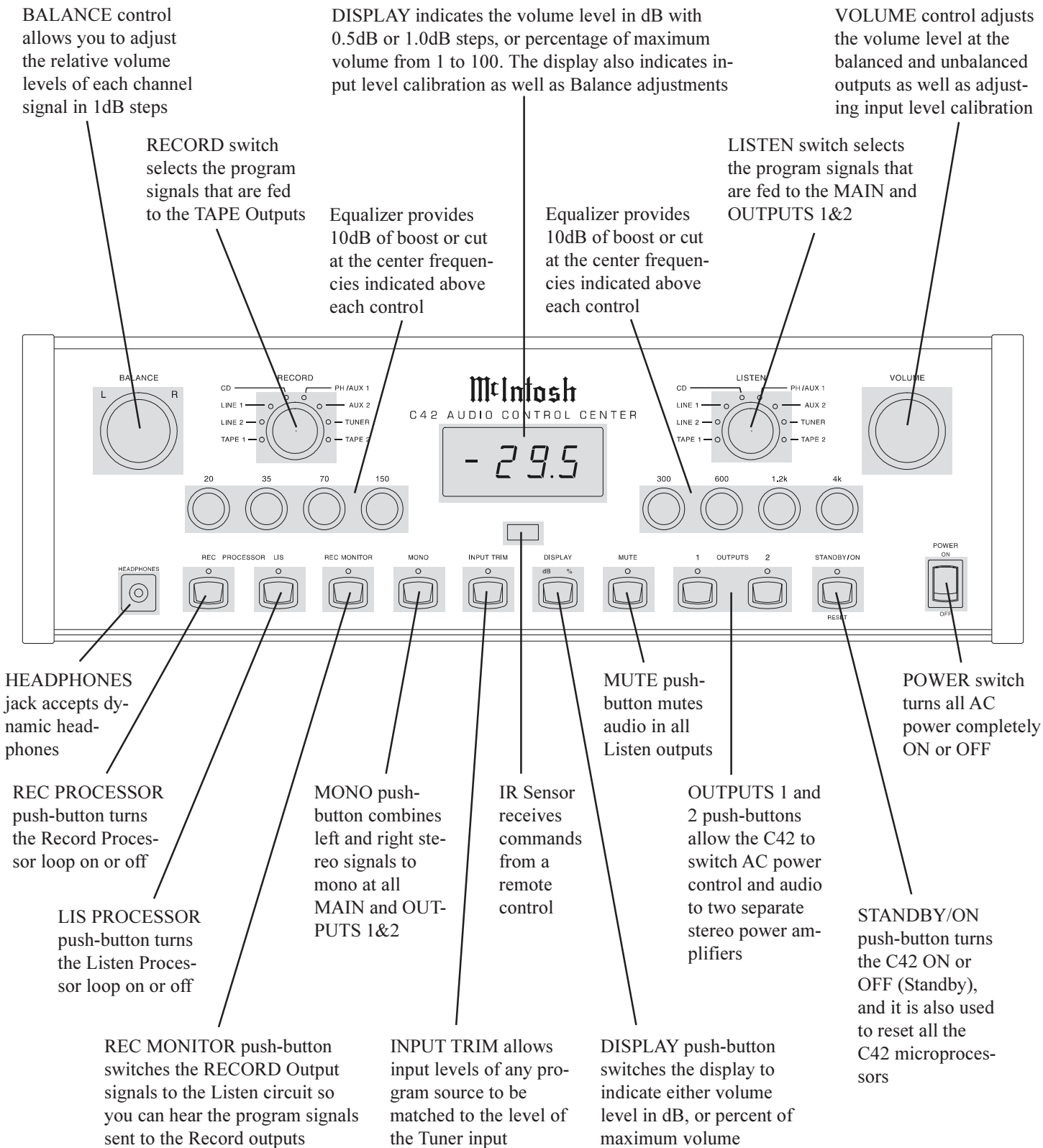

How to Trim Input Volume Levels

Various components can have slightly different volume levels. This results in the constant need to readjust the C42 volume control when listening to different program sources. A volume trim feature on the C42 allows you to adjust or trim the volume levels of the various inputs so they are the same. The trimmed volume levels for all the inputs are based on the reference volume level of the TUNER input, which is fixed. Refer to Figure 1 during the following steps:

NOTE: Trimmed volume levels will affect only the LISTEN signals. The RECORD output levels are not affected by the trim procedure and do not change. Any TRIM adjustments made are retained in permanent memory and can be changed only by performing a new TRIM procedure.

1. Switch the C42 LISTEN selector to TUNER and adjust the volume control to the desired listening level.
2. Press the INPUT TRIM push-button. The VOLUME display will read "00" and the Red LED above the push-button will turn ON.

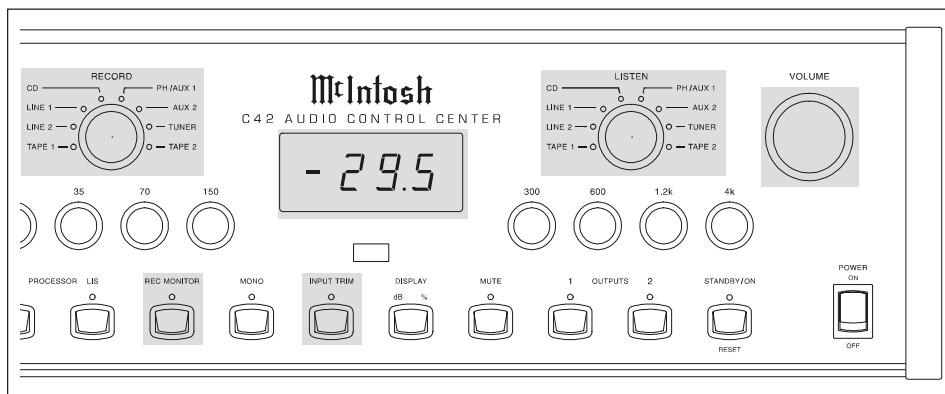

Figure 1

3. Switch to another input such as CD.
4. Adjust the volume control either up or down as needed until the listening level of the second input source is the same as the Tuner level. The display will automatically switch to dB and indicate the new setting for volume level with a range of ± 12 dB.
5. Repeat Steps 3 and 4 to trim the volume levels for other LISTEN input sources.
6. Press the INPUT TRIM push-button a second time to exit the TRIM mode and the Red LED will turn OFF.

NOTE: Whenever you select a program source with trimmed volume levels, the volume DISPLAY will automatically move up or down to reflect the desired volume level set for that source.

Optional Trim Procedure

1. Switch the RECORD selector to TUNER.
2. Switch the LISTEN selector to a different input source such as CD.
3. Press the REC MONITOR push-button and adjust the volume control to the desired listening level.
4. Press the INPUT TRIM push-button. The VOLUME display will read "00" and the Red LED above the push-button will turn ON.
5. Press the REC MONITOR a second time to return to the LISTEN mode.
6. Adjust the volume control up or down as needed until the listening level of the second input source is the same as the Tuner level. The VOLUME display will automatically switch to dB and indicate the new setting for volume level with a range of ± 12 dB.
7. Make an instant comparison between the two volume

levels by switching REC MONITOR ON or OFF and make further adjustments as needed to match the volume levels.

8. Press INPUT TRIM a second time to exit the TRIM mode.

NOTE: The following table may be used to record your level trim adjustments for the various inputs.

Input Source	Default Setting	New Setting
Tuner	0	
Tape 1	0	
Tape 2	0	
Line 1	0	
Line 2	0	
Ph/Aux 1	0	
Aux 2	0	
CD	0	

How to Operate the C42

Power On

Press the POWER switch to ON. The Red LED, above the STANDBY/ON Pushbutton, lights to indicate the C42 is in Standby Mode. To turn on the C42 press the STANDBY/ON push-button. Refer to Figure 2.

NOTE: You may also turn on the C42 using the remote control.

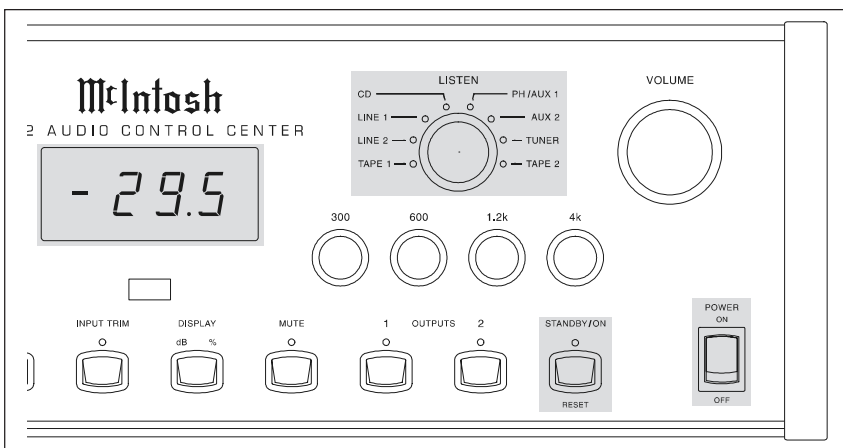

Figure 2

Source Selection

Select the desired listening source with the LISTEN Switch.

Volume Control

Adjust the VOLUME control for the desired listening level.

Volume Level Display

Press the DISPLAY push-button to select either dB or % volume display. The dB readings range from -92dB to +15dB, in 0.5dB or 1dB steps. The % volume display reads from 0 to 100.

Reset of Microprocessors

In the event that the controls of the C42 stop functioning, there is a user reset function built in. While the C42 is on depress and hold in the STANDBY/ON/RESET push button for five seconds, this will reset the C42 microprocessors.

NOTE: The above condition is usually caused by either interruptions in AC power and/or major changes in voltage.

Balance Control

Adjust the BALANCE control as needed to achieve approximately equal listening volume levels in each loudspeaker. Turn the BALANCE to the Left to emphasize the left channel by reducing the level of the right channel. Turn the BALANCE to the right to emphasize the right channel by reducing the level of the left channel.

Balance Display

As soon as the BALANCE control is turned, the Volume Display reads the balance change from 1 to 107 in one dB steps. After approximately 3 seconds the Volume Display returns to the Volume reading. To verify the balance setting without changing it, move the control one detent in either direction. The display will indicate the selected balance changes for approximately 3 seconds and then return to the volume display. Refer to Figure 3.

The “L” or “R” will illuminate red to indicate which channel has been emphasized by the BALANCE control. It is perfectly natural for the BALANCE control to be off the center to achieve the correct listening volume from each loudspeaker in many listening rooms. Listening balance can also vary with different program sources, room acoustics and listening positions relative to the loudspeakers.

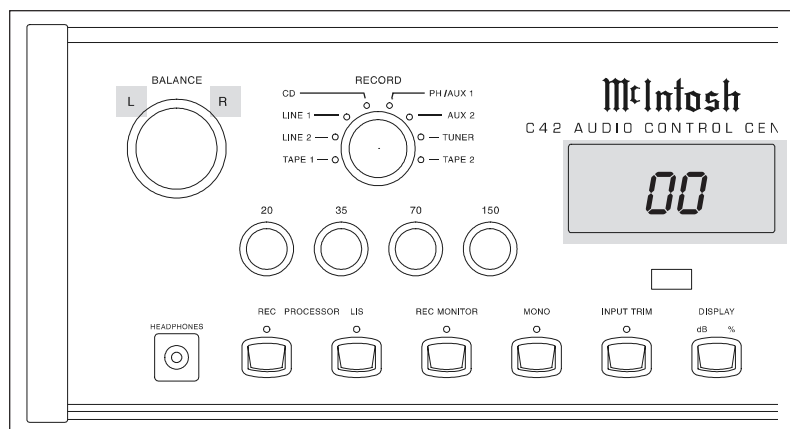

Figure 3

Equalizer Controls

Each of the eight Equalizer Frequency controls will raise or lower by approximately 10dB, the amplitude of the band of frequencies centered at the frequency marked above the

controls. Both left and right channels are affected. At the center detent or flat position of the controls, all equalizer circuit components are removed from the signal path.

Mono

Press the MONO push-button to combine left and right stereo signals to mono at all MAIN, OUTPUT 1&2 and HEADPHONES Outputs.

Mute

Press the MUTE push-button to mute audio in all Listen outputs.

How to change dB volume Steps

The Volume Control can adjust volume level in either 1dB or 0.5dB steps. Refer To Figure 5.

1. To change from one volume step mode to the other, first press the Input Trim Push-button and then the Display push-button.
2. To return to the previous step mode, press the Input Trim and Display push-buttons a second time.

NOTE: The display will indicate the dB level change modes according to your selection. This procedure does not affect the % volume display.

How To Make A Tape Recording

The separate RECORD and LISTEN switches allow you to make a tape recording from one program source while listening to another. You can also listen (monitor) to the recorded signal off

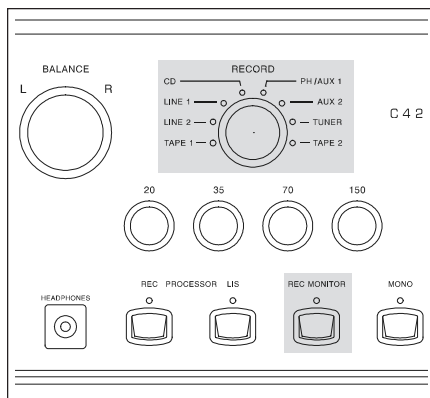

Figure 4

the tape, a fraction of a second later, during recording when a three head tape recorder is used. You can also listen to the signal being fed to the tape recorder by pressing the REC MONITOR push-button. Refer to Figure 4.

1. Select the desired program source to record with the front panel RECORD selector switch.
2. Adjust the record level using the tape recorder volume control.
3. To listen to the signal being fed to the tape recorder, press the REC (Record) MONITOR push-button.
4. To listen to the tape playback of the program source just recorded, turn the LISTEN switch to the desired input.

NOTE: The C42 RECORD OUTPUTS are not affected by the VOLUME or BALANCE controls. To listen to a different program source while recording, turn the LISTEN switch to the desired source. The recording process will not be affected and will continue.

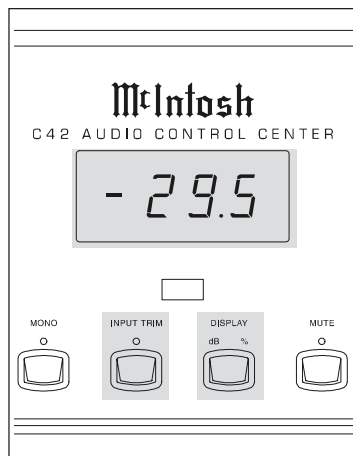

Figure 5

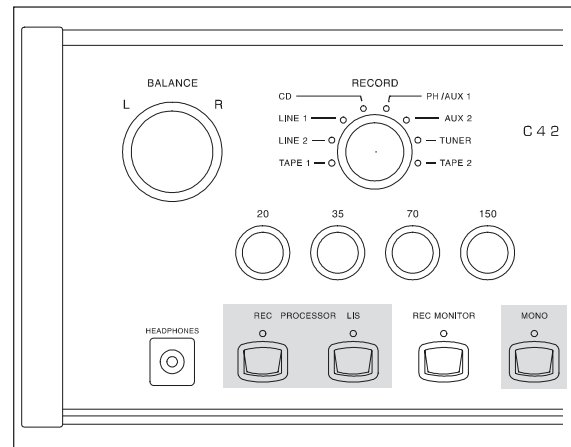
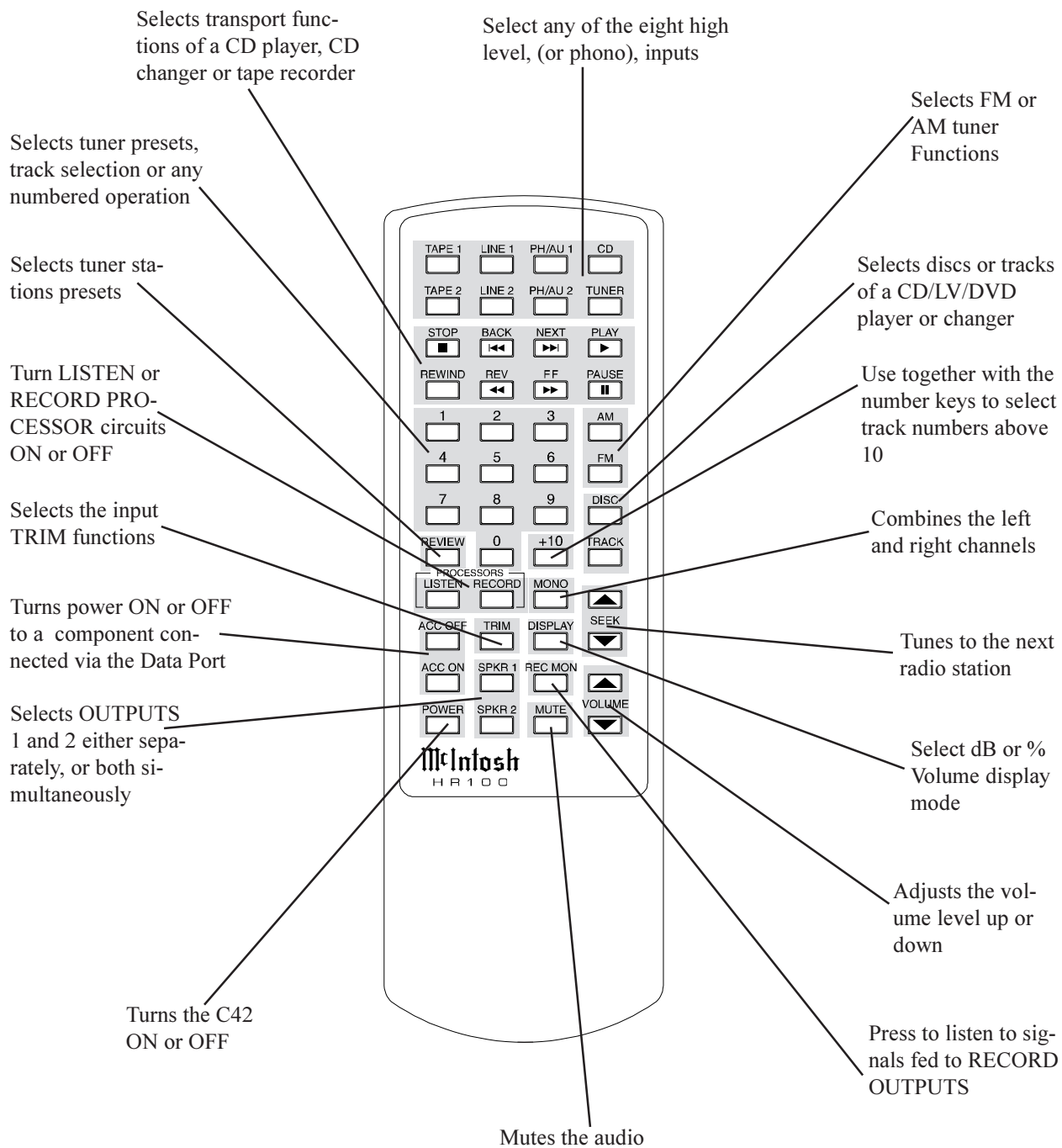

Figure 6

How to use a Signal Processor

Access and operate a signal processor connected to the LISTEN PROCESSOR jacks by pressing the front panel LIS (Listen) PROCESSOR push-button. This processor will affect only the LISTEN signals. Refer to Figure 6. Access and operate a signal processor connected to the RECORD PROCESSOR jacks by pressing the front panel REC (Record) processor push-button. This processor will affect only the RECORD signals sent to tape recorders.

Remote Control Push-Buttons



How to Operate the Remote Control

Mute

Press the MUTE push-button to mute audio in all LISTEN outputs.

Mono

Press the MONO push-button to combine left and right stereo signals to mono at all MAIN, AMPLIFIER, LISTEN and HEADPHONES Outputs.

Audio

Press any of the eight Audio push-buttons to select a LISTEN program source.

CD/Tape

Use these push-buttons to operate a CD player, CD changer or tape recorder, when the component is connected to the C100 with a McIntosh RCT Translator.

Numbered and +10 Push-buttons

Press push-buttons 0 through 9 to access tuner station presets, CD tracks or CD discs. When using a McIntosh MCD7010 CD player, access track numbers higher than 10 by first pressing +10 and then a number push-button.

Disc and Track

Use the DISC and TRACK push-buttons when a CD player or changer is being used.

Tuner Push-buttons

Use with a McIntosh tuner. Select AM or FM broadcast band. Press and release SEEK Up or Down to move from station to station. Press and hold a SEEK push-button to move continuously from station to station. Press REVIEW to start the automatic brief audition of each of the presets stored in the tuner memory. Press REVIEW a second time to stop on a station preset and exit the Review process.

Processors

Press the LISTEN PROCESSOR push-button to activate rear panel processor connections to add signal processing from an external processor to the LISTEN Outputs. Press the RECORD PROCESSOR push-button to activate rear panel connections to add signal processing from an external processor to the RECORD outputs.

Record Monitor

Press the REC (Record) Monitor push-button to listen to the signals being fed to the RECORD OUTPUTS.

Volume

Press the Up or Down VOLUME push-button to raise or lower the listening volume level. The Record Outputs are not affected.

Trim

Press TRIM to enter the Input Volume Level Trim mode. Press a second time to exit the Trim mode.

Display

Press the DISPLAY push-button to cycle the Volume Display between dB and % of volume indications.

ACC ON - OFF

Press ACC ON or ACC OFF to turn power ON and OFF of components that are connected with a McIntosh RCT Translator - Repeater. Only the ACC ON push-button is active with the McIntosh LV or DVD Disc Player.

NOTE: When other brands of components are connected with a McIntosh RCT Translator, refer to the RCT Owner's Manual for further information on alternate remote control push-button functions.

Specifications

Frequency Response

+0, -0.5dB from 20Hz to 20,000Hz

Total Harmonic Distortion

0.002% maximum from 20Hz to 20,000Hz

Signal To Noise Ratio

Phono: 86dB (A Weighted)

High Level: 97dB (A Weighted)

Rated Output Voltage

Main and Outputs 1 and 2: 2.5Vrms

Maximum Voltage Output

Main and Outputs 1 and 2: 10Vrms

Output Impedance

240 ohms

Input Impedance

Phono: 47K ohms, 65pf

High Level: 22K ohms

Sensitivity

Phono: 4.5mV for rated output

High Level: 450mV for rated output

Maximum Input Signal

Phono: 50mV

High Level: 5V

Voltage Gain

Phono to Tape Out: 40dB

High Level to Tape Out: 0dB

High Level to Main Out: 15dB

Power Requirements

100 Volts 50/60Hz, 30 watts

110 Volts 50/60Hz, 30 watts

120 Volts 50/60Hz, 30 watts

220 Volts 50/60Hz, 30 watts

230 Volts 50/60Hz, 30 watts

240 Volts 50/60Hz, 30 watts

Note: Refer to the rear panel of the C42 for the correct voltage.

Dimensions

17-1/2 inches (44.5cm) W, 5-3/8 inches (13.7cm) H, 17.5 inches (44.5cm) D, including clearance for connectors

Performance Chart

Equalizer Frequency Response



Packing Instructions

In the event it is necessary to repack the equipment for shipment, the equipment must be packed exactly as shown below. It is very important that the four plastic feet are attached to the bottom of the equipment. This will ensure the proper equipment location on the bottom pad. Failure to do this will result in shipping damage.

Use the original shipping carton and interior parts only if they are all in good serviceable condition. If a shipping carton or any of the interior part(s) are needed, please call or write Customer Service Department of McIntosh Laboratory. Please see the Parts List for the correct part numbers.

Quantity	Part Number	Description
1	033838	Shipping carton only
2	033837	End Cap
1	033836	Inside carton only
1	033725	Top Pad
1	034008	Bottom pad
1	034037	Inner carton pad
4	017218	Plastic foot
4	100159	#10-32 x 3/4" Machine screw
4	104083	#10 x 7/16" Flat washer
1	049259	Shipping carton complete with all the above parts

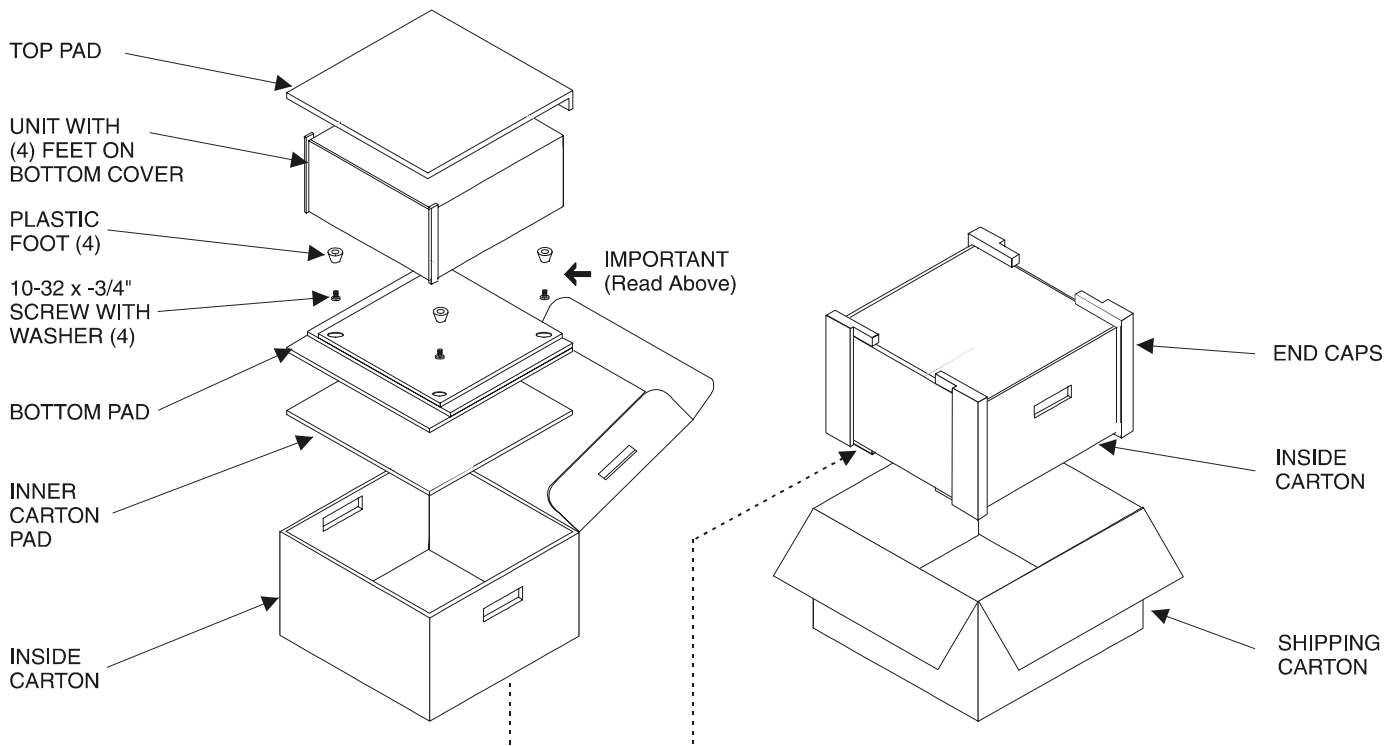

McIntosh[®]

McIntosh Laboratory, Inc.
2 Chambers Street
Binghamton, NY 13903

McIntosh Part No. 040627